



USB-Blaster Download Cable

User Guide



101 Innovation Drive
San Jose, CA 95134
www.altera.com

UG-USB81204-2.3
P25-10325-03

Document Version: 2.3
Document Date: May 2007

Copyright © 2007 Altera Corporation. All rights reserved. Altera, The Programmable Solutions Company, the stylized Altera logo, specific device designations, and all other words and logos that are identified as trademarks and/or service marks are, unless noted otherwise, the trademarks and service marks of Altera Corporation in the U.S. and other countries. All other product or service names are the property of their respective holders. Altera products are protected under numerous U.S. and foreign patents and pending applications, maskwork rights, and copyrights. Altera warrants performance of its semiconductor products to current specifications in accordance with Altera's standard warranty, but reserves the right to make changes to any products and services at any time without notice. Altera assumes no responsibility or liability arising out of the application or use of any information, product, or service described herein except as expressly agreed to in writing by Altera Corporation. Altera customers are advised to obtain the latest version of device specifications before relying on any published information and before placing orders for products or services.



Printed on recycled paper



I.S. EN ISO 9001

Chapter 1. Setting Up the USB-Blaster Download Cable

Introduction	1-1
Device Support	1-1
Power Requirements	1-1
Software Requirements	1-2
Hardware Setup	1-2
Software Setup	1-3
Installing the USB-Blaster Driver on Windows 2000 and Windows XP Systems	1-3
Installing the USB-Blaster Driver on Linux	1-4
Setting Up the USB-Blaster Hardware in the Quartus II Software	1-5

Chapter 2. USB-Blaster Specifications

Overview	2-1
USB-Blaster Connections	2-1
Voltage Requirements	2-1
Cable-to-Board Connection	2-2
USB-Blaster Plug Connection	2-2
Circuit Board Header Connection	2-4
Operating Conditions	2-4
USB-Revision	2-6
References	2-7



About this User Guide

Revision History The table below displays the revision history for the chapters in this User Guide.

Date	Version	Changes Made
May 2007	2.3	<ul style="list-style-type: none">• Updated “Introduction”.• Added warning note about USB-Blaster cable in “Hardware Setup” section.• Added information on Linux setup in “Installing the USB-Blaster Driver on Linux” section.• Added footnote note on driver information just before the “Setting Up the USB-Blaster Hardware in the Quartus II Software” section.• Updated USB-Blaster installation procedure for QII 6.1 (32-bit or 64-bit) in “Installing the USB-Blaster Driver on Windows 2000 and Windows XP Systems” section.
March 2007	2.2	Update to “Installing the USB-Blaster Driver on Windows 2000 and Windows XP Systems” section.
July 2006	2.1	Minor update to Chapter 2.
June 2006	2.0	Added USB-Blaster Revision section, updated Figure 2–1, Table 2–1, and Table 2–7. Added Table 2–6.
December 2004		Update to conditions in Table 2–2.
November 2004	1.1	Re-release.
July 2004	1.0	First publication.

How to Contact Altera

For the most up-to-date information about Altera products, refer to the following table.

Contact (1)	Contact Method	Address
Technical support	Website	www.altera.com/support
Technical training	Website	www.altera.com/training
	Email	custrain@altera.com
Product literature	Website	www.altera.com/literature
Altera literature services	Email	literature@altera.com
Non-technical support (General) (Software Licensing)	Email	nacomp@altera.com
	Email	authorization@altera.com







Note to table:

(1) You can also contact your local Altera sales office or sales representative.

Typographic Conventions

This document uses the typographic conventions shown below.

Visual Cue	Meaning
Bold Type with Initial Capital Letters	Command names, dialog box titles, checkbox options, and dialog box options are shown in bold, initial capital letters. Example: Save As dialog box.
bold type	External timing parameters, directory names, project names, disk drive names, filenames, filename extensions, and software utility names are shown in bold type. Examples: f_{MAX} , lqdesigns directory, d: drive, chiptrip.gdf file.
<i>Italic Type with Initial Capital Letters</i>	Document titles are shown in italic type with initial capital letters. Example: <i>AN 75: High-Speed Board Design</i> .
<i>Italic type</i>	Internal timing parameters and variables are shown in italic type. Examples: <i>t_{PIA}</i> , <i>n + 1</i> . Variable names are enclosed in angle brackets (< >) and shown in italic type. Example: < <i>file name</i> >, < <i>project name</i> >.pdf file.
Initial Capital Letters	Keyboard keys and menu names are shown with initial capital letters. Examples: Delete key, the Options menu.
“Subheading Title”	References to sections within a document and titles of on-line help topics are shown in quotation marks. Example: “Typographic Conventions.”

Visual Cue	Meaning
Courier type	<p>Signal and port names are shown in lowercase Courier type. Examples: <code>data1</code>, <code>tdi</code>, <code>input</code>. Active-low signals are denoted by suffix <code>n</code>, e.g., <code>resetn</code>.</p> <p>Anything that must be typed exactly as it appears is shown in Courier type. For example: <code>c:\qdesigns\tutorial\chiptrip.gdf</code>. Also, sections of an actual file, such as a Report File, references to parts of files (e.g., the AHDL keyword <code>SUBDESIGN</code>), as well as logic function names (e.g., <code>TRI</code>) are shown in Courier.</p>
1., 2., 3., and a., b., c., etc.	Numbered steps are used in a list of items when the sequence of the items is important, such as the steps listed in a procedure.
	Bullets are used in a list of items when the sequence of the items is not important.
	The checkmark indicates a procedure that consists of one step only.
	The hand points to information that requires special attention.
	The caution indicates required information that needs special consideration and understanding and should be read prior to starting or continuing with the procedure or process.
	The warning indicates information that should be read prior to starting or continuing the procedure or processes
	The angled arrow indicates you should press the Enter key.
	The feet direct you to more information on a particular topic.

Introduction

The USB-Blaster™ download cable interfaces a USB port on a host computer to an Altera® FPGA mounted on a printed circuit board. The cable sends configuration data from the PC to a standard 10-pin header connected to the FPGA. You can use the USB-Blaster cable to iteratively download configuration data to a system during prototyping or to program data into the system during production.

Device Support

The USB-Blaster download cable allows you to program and configure Altera devices. Specifically, you can do the following:

- Download configuration data to FPGA devices:
 - Stratix® II, Stratix II GX, Stratix GX, and Stratix family of devices
 - Cyclone™ II and Cyclone family of devices
 - APEX™ II and APEX 20K family of devices
 - ACEX® 1K devices
 - Mercury™ devices
 - FLEX™ 10K, FLEX 10KE, and FLEX 10KA family of devices
 - Excalibur™ devices
- Download configuration data to User Flash Memory (UFM) devices:
 - MAX® II family of devices
- Download configuration data to EEPROM-based devices:
 - MAX 3000 and MAX 7000 family of devices
- Perform in-system programming of advanced configuration devices:
 - EPC2, EPC4, EPC8, EPC16, and EPC1441 devices
- Perform in-system programming of serial configuration devices:
 - EPCS1, EPCS4, EPCS16, and EPCS64 devices

In addition, the USB-Blaster download cable supports target systems using 5.0 V TTL, 3.3 V LVTTTL/LVCMOS, and single-ended I/O standards from 1.5 V to 3.3 V.

Power Requirements

The USB-Blaster download cable requires the following power sources:

- 5.0 V from the USB cable
- Between 1.5 V and 5.0 V from the target circuit board

Software Requirements

The USB-Blaster download cable is only available for Windows 2000, Windows XP, and Linux systems.

Use the Quartus® II software version 4.0 or later to configure your device. The USB-Blaster download cable also supports the following:

- Quartus II Programmer (for programming and configuration)
- Quartus II SignalTap® II Logic Analyzer (for logic analysis)
- Quartus II Programmer (standalone version)
- Quartus II SignalTap II logic analyzer (standalone version)

Hardware Setup

This section describes how to install and set up the USB-Blaster download cable for device configuration or programming.



For plug and header dimensions, pin names, and operating conditions, see Chapter 2, “USB-Blaster Specifications.”

Connect your USB-Blaster download cable to the circuit board as instructed below.

1. Disconnect the power cable from the circuit board.
2. Connect the USB cable to the USB port on your PC and to the USB-Blaster port.
3. Connect the USB-Blaster download cable to the 10-pin header on the device board. [Figure 1-1](#) shows the USB-Blaster download cable and the circuit board connector.



To avoid damaging the USB-Blaster cable, first unplug the cable from the 10-pin header on the target board before unplugging the cable from the USB port on your PC. It is safest to remove power first from the target board before unplugging the USB-Blaster cable.

Figure 1–1. The USB-Blaster Download Cable

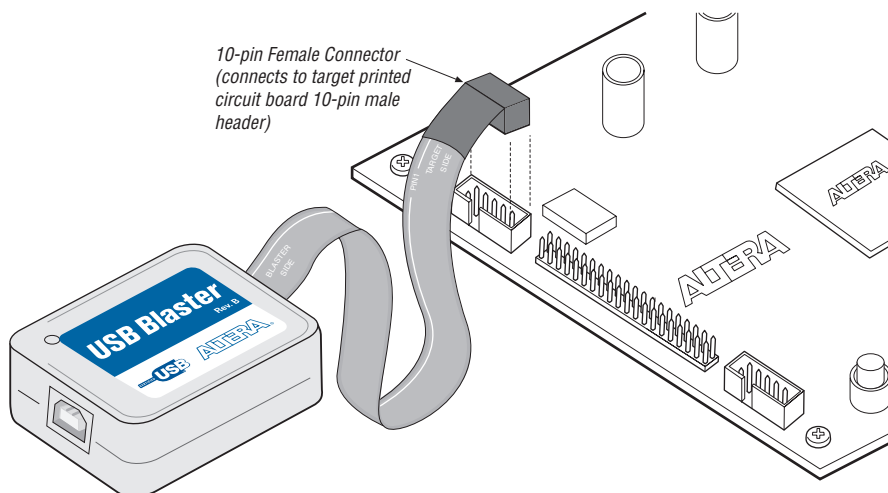

4. Reconnect the power cable to reapply power to the circuit board.

 The **Found New Hardware** wizard may open and prompt you to install a new hardware driver. Close the wizard and install the hardware driver using the instructions provided in “[Installing the USB-Blaster Driver on Windows 2000 and Windows XP Systems](#)” below.

Software Setup

This section describes the following:

- Installing the USB-Blaster driver
- Setting up the USB-Blaster hardware in the Quartus II software

Installing the USB-Blaster Driver on Windows 2000 and Windows XP Systems

This section describes how to install the USB-Blaster driver on Windows 2000 and Windows XP systems.

Before you begin the installation, verify the USB-Blaster driver is located in your directory: `\<Quartus II system directory>\drivers\usb-blaster`

 If the driver is not in your directory, download the USB-Blaster driver from the Altera web site:
www.altera.com/support/software/drivers

To install the driver, follow the directions below:

1. Plug in the USB-Blaster download cable to the PC.
2. On the **Found New Hardware Wizard** window, click **No, not this time** and then click **Next** to continue.
3. Select **Install from a list of specific location (Advanced)** and click **Next** to continue.
4. Select **Don't search. I will choose the driver to install**. Click **Next**.
5. Select **Sound, video and game controllers**, and click **Next** to continue.
6. Select **Have Disk** and browse to the location of the driver on your system: \<Quartus II system directory>\drivers\usb-blaster. Click **OK**.



For Quartus II version 6.1 and later, select the appropriate driver version based on the 64-bit or 32-bit Quartus II version.

7. Select **Altera USB-Blaster** and click **Next** to continue.
8. Click **Next** to install the driver.
9. Click **Continue Anyway** when the Hardware Installation warning appears.
10. Click **Finish** in the Completing the Add/Remove Hardware Wizard window. Reboot your system.

Installing the USB-Blaster Driver on Linux

This section describes how to install the USB-Blaster driver on Linux.

The Quartus II software uses the built-in USB drivers (usbfs) on RedHat Linux to access the USB-Blaster download cable. By default, *root* is the only user allowed to use usbfs. You must change the permission on the ports before you can use the USB-Blaster download cable to program devices with the Quartus II software.

You must have system administration (*root*) privileges to configure the USB-Blaster download cable drivers.

1. Add the following lines to the `/etc/hotplug/usb.usermap` file.

```
#  
# Altera USB-Blaster  
#  
usbblaster 0x03 0x09fb 0x6001 0x0 0x0 0x0 0x0 0x0 0x0  
0x0 0x0 0x0  
usbblaster 0x03 0x09fb 0x6002 0x0 0x0 0x0 0x0 0x0 0x0  
0x0 0x0 0x0  
usbblaster 0x03 0x09fb 0x6003 0x0 0x0 0x0 0x0 0x0 0x0  
0x0 0x0 0x0
```

2. Create a file named `/etc/hotplug/usb/usbblaster` and add the following lines to it.

```
#!/bin/sh  
# USB-Blaster hotplug script  
# Allow any user to access the cable  
chmod 666 $DEVICE
```

3. Make the file executable.
4. Complete your installation by setting up the programming hardware in the Quartus II software as described in the following section.



Refer to www.altera.com/support/software/drivers for more information on USB-Blaster driver installation.

Setting Up the USB-Blaster Hardware in the Quartus II Software

Use the following steps to set up the USB-Blaster hardware in the Quartus II software:

1. Start the Quartus II software.
2. Choose **Programmer** (Tools menu).
3. Click **Hardware Setup**. The **Hardware Settings** tab of the **Hardware Setup** dialog box is displayed (Figure 1–2).

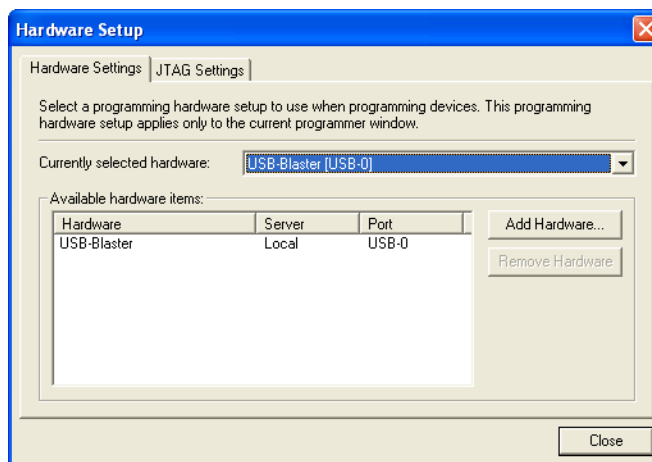
Figure 1–2. Hardware Setup Dialog Box

4. From the drop-down menu, select **USB-Blaster [USB-0]** (Figure 1–2).
5. Click **Close** to close the **Hardware Setup** dialog box.
6. In the **Mode** list, select the desired mode (Programmer window). Table 1–1 describes each mode.

 The USB-Blaster supports the Joint Test Action Group (JTAG), Passive Serial Programming, and Active Serial modes.

Table 1–1. Programming Modes

Mode	Mode Description
Joint Test Action Group (JTAG)	Programs or configures all Altera devices supported by Quartus II software, excluding FLEX 6000.
In-Socket Programming	Not supported by the USB-Blaster.
Passive Serial Programming	Configures all Altera devices supported by Quartus II software excluding MAX 3000 and MAX 7000 devices.
Active Serial Programming	Programs a single EPCS1, EPCS4, EPCS16, and EPCS64 serial configuration device.



For details about programming devices and creating secondary programming files, see the *Programming & Configuration* chapter of the *Introduction to Quartus II Handbook*.

For further information, see the Programming module of the Quartus II online tutorial.

For further information, refer to the following topics in the Quartus II software Help menu:

- Changing the Hardware Setup
- Programmer Introduction
- Overview: Working with Chain Description Files
- Overview: Converting Programming Files

Overview

This chapter provides comprehensive information about the USB-Blaster™ download cable including the following:

- USB-Blaster connections
 - Voltage requirements
 - Cable-to-board connection
 - USB-Blaster plug connection
 - Circuit board header connection
- Operating conditions
- USB-Blaster Revision

USB-Blaster Connections

The USB-Blaster cable has a USB universal plug that connects to the PC USB port, and a 10-pin female plug that connects to the circuit board. Data is downloaded from the USB port on the PC through the USB-Blaster cable to the circuit board via the connections discussed in this section.

Voltage Requirements

The USB-Blaster $V_{CC}(TRGT)$ pin must be connected to a specific voltage for the device being programmed. Connect pull-up resistors to the same power supply as the USB-Blaster $V_{CC}(TRGT)$. See [Table 2-1](#).

Table 2-1. USB-Blaster $V_{CC}(TRGT)$ Pin Voltage Requirements (Part 1 of 2)	
Device Family	USB-Blaster V_{CC} Voltage Required
MAX II device	As specified by V_{CCIO} of Bank 1
MAX 7000S device	5 V
MAX 7000AE and MAX 3000A devices	3.3 V
MAX 7000B device	2.5 V
Stratix, Stratix II, Stratix GX, and Stratix II GX devices	As specified by V_{CCSEL}
Cyclone II, Cyclone, APEX II, APEX 20K, and Mercury devices	As specified by V_{CCIO}
FLEX 10K, FLEX 8000, and FLEX 6000 devices	5 V
FLEX 10KE device	2.5 V
FLEX 10KA and FLEX 6000A devices	3.3 V

Device	VCC Voltage
EPC2 device	5 V or 3.3 V
EPC4, EPC8, and EPC16 devices	3.3 V
EPCS1, EPCS4, EPCS16, and EPCS64 devices	3.3 V

Cable-to-Board Connection

A standard USB cable connects to the USB port on the device. [Figure 2-1](#) shows a block diagram of the USB-Blaster download cable.

Figure 2-1. USB-Blaster Block Diagram

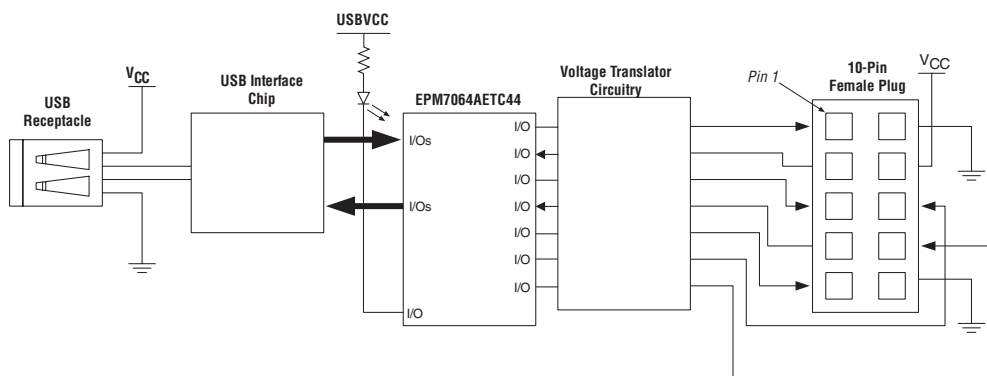

USB-Blaster Plug Connection

The 10-pin female plug connects to a 10-pin male header on the circuit board containing the target device. [Figure 2-2](#) shows the dimensions of the female plug.

Figure 2–2. USB-Blaster 10-Pin Female Plug Dimensions

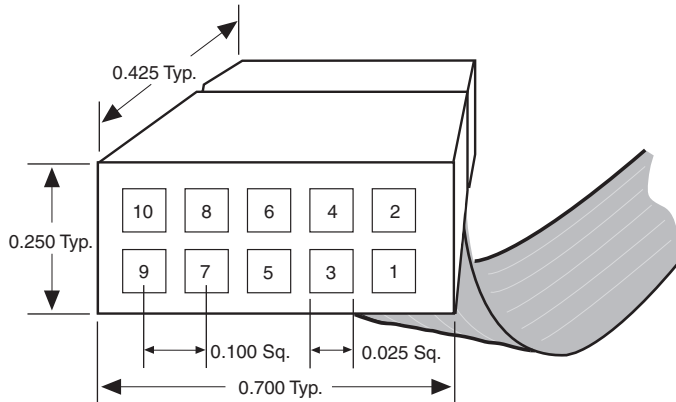

Dimensions are shown in inches. Spacing between pin centers is 0.1 inches.

Table 2–2 identifies the 10-pin female plug pin names and the corresponding programming mode.

Table 2–2. USB-Blaster Female Plug Signal Names & Programming Modes

Pin	AS Mode		PS Mode		JTAG Mode	
	Signal Name	Description	Signal Name	Description	Signal Name	Description
1	DCLK	Clock signal	DCLK	Clock signal	TCK	Clock signal
2	GND	Signal ground	GND	Signal ground	GND	Signal ground
3	CONF_DONE	Configuration done	CONF_DONE	Configuration done	TDO	Data from device
4	VCC (TRGT)	Target power supply	VCC (TRGT)	Target power supply	VCC (TRGT)	Target power supply
5	nCONFIG	Configuration control	nCONFIG	Configuration control	TMS	JTAG state machine control
6	nCE	Cyclone chip enable	–	No connect	–	No connect
7	DATAOUT	Active serial data out	nSTATUS	Configuration status	–	No connect
8	nCS	Serial configuration device chip select	–	No connect	–	No connect
9	ASDI	Active serial data in	DATA0	Data to device	TDI	Data to device
10	GND	Signal ground	GND	Signal ground	GND	Signal ground



The circuit board must supply $V_{CC(TRGT)}$ and ground to the USB-Blaster cable for the I/O drivers.

Circuit Board Header Connection

The circuit board's 10-pin male header, which connects to the USB-Blaster cable's 10-pin female plug, has two rows of five pins. These pins are connected to the device's programming or configuration pins. Figure 2–3 shows the dimensions of a typical 10-pin male header.

Figure 2–3. 10-Pin Male Header Dimensions

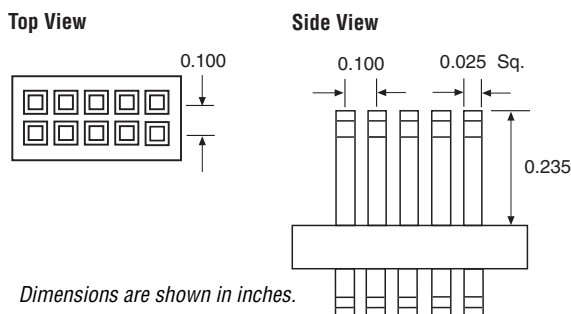

Operating Conditions

Tables 2–3 through 2–5 summarize the maximum ratings, recommended operating conditions, and DC operating conditions for the USB-Blaster cable.

Table 2–3. USB-Blaster Cable Absolute Maximum Ratings

Symbol	Parameter	Conditions	Min	Max	Unit
$V_{CC(TRGT)}$	Target supply voltage	With respect to ground	–0.3	5.5	V
$V_{CC(USB)}$	USB supply voltage	With respect to ground	–0.5	6.0	V
I_i	Input current	TDO or dataout	–10.0	10.0	mA
I_o	Output current for Rev. A and Rev. B cable	TCK, TMS, TDI, nCS, nCE	–20.0	20.0	mA
	Output current for Rev. C cable		–50.0	50.0	mA

Table 2–4. USB-Blaster Cable Recommended Operating Conditions

Symbol	Parameter	Conditions	Min	Max	Unit
$V_{CC(TRGT)}$	Target supply voltage, 5.0-V operation		4.75	5.25	V
	Target supply voltage, 3.3-V operation		3.0	3.6	V
	Target supply voltage, 2.5-V operation		2.375	2.625	V
	Target supply voltage, 1.8-V operation		1.71	1.89	V
	Target supply voltage, 1.5-V operation		1.43	1.57	V

Table 2–5. USB-Blaster Cable (Rev. A & B) DC Operating Conditions

Symbol	Parameter	Conditions	Min	Max	Unit
V_{IH}	High-level input voltage		$V_{CC(TRGT)} - 0.2$		V
V_{IL}	Low-level input voltage			0.15	V
V_{OH}	5.0-V high-level output voltage	$V_{CC(TRGT)} = 4.5\text{ V}, I_{OH} = 1\text{ mA}$	4.4		V
	3.3-V high-level output voltage	$V_{CC(TRGT)} = 3.0\text{ V}, I_{OH} = 1\text{ mA}$	2.9		V
	2.5-V high-level output voltage	$V_{CC(TRGT)} = 2.375\text{ V}, I_{OH} = 1\text{ mA}$	2.275		V
	1.8-V high-level output voltage	$V_{CC(TRGT)} = 1.71\text{ V}, I_{OH} = 1\text{ mA}$	1.61		V
	1.5-V high-level output voltage	$V_{CC(TRGT)} = 1.43\text{ V}, I_{OH} = 1\text{ mA}$	1.33		V
V_{OL}	5.0-V low-level output voltage	$V_{CC(TRGT)} = 5.5\text{ V}, I_{OL} = 1\text{ mA}$		0.125	V
	3.3-V low-level output voltage	$V_{CC(TRGT)} = 3.6\text{ V}, I_{OL} = 1\text{ mA}$		0.125	V
	2.5-V low-level output voltage	$V_{CC(TRGT)} = 2.625\text{ V}, I_{OL} = 1\text{ mA}$		0.125	V
	1.8-V low-level output voltage	$V_{CC(TRGT)} = 1.89\text{ V}, I_{OL} = 1\text{ mA}$		0.125	V
	1.5-V low-level output voltage	$V_{CC(TRGT)} = 1.57\text{ V}, I_{OL} = 1\text{ mA}$		0.125	V
$I_{CC(USB)}$	Operating current (No Load)	(Typical $I_{CC(USB)} = 80\text{ mA}$)		150	mA

Symbol	Parameter	Conditions	Min	Max	Unit
V _{IH}	High-level input voltage	V _{CC(TRGT)} ≥ 2.0 V	2.0		V
		V _{CC(TRGT)} < 2.0 V	V _{CC(TRGT)}		V
V _{IL}	Low-level input voltage	V _{CC(TRGT)} ≥ 2.0 V		0.8	V
		V _{CC(TRGT)} < 2.0 V		0	V
V _{OH}	5.0-V high-level output voltage	V _{CC(TRGT)} = 4.5 V, I _{OH} = -10 mA	3.8		V
	3.3-V high-level output voltage	V _{CC(TRGT)} = 3.0 V, I _{OH} = -8 mA	2.3		V
	2.5-V high-level output voltage	V _{CC(TRGT)} = 2.375 V, I _{OH} = -6 mA	1.8		V
	1.8-V high-level output voltage	V _{CC(TRGT)} = 1.71 V, I _{OH} = -4 mA	1.2		V
	1.5-V high-level output voltage	V _{CC(TRGT)} = 1.43 V, I _{OH} = -2 mA	1.0		V
V _{OL}	5.0-V low-level output voltage	V _{CC(TRGT)} = 5.5 V, I _{OL} = 10 mA		0.8	V
	3.3-V low-level output voltage	V _{CC(TRGT)} = 3.6 V, I _{OL} = 8 mA		0.7	V
	2.5-V low-level output voltage	V _{CC(TRGT)} = 2.625 V, I _{OL} = 6 mA		0.6	V
	1.8-V low-level output voltage	V _{CC(TRGT)} = 1.89 V, I _{OL} = 4 mA		0.5	V
	1.5-V low-level output voltage	V _{CC(TRGT)} = 1.57 V, I _{OL} = 2 mA		0.4	V
I _{CC(USB)}	Operating current (No Load)	(Typical I _{CC(USB)} = 80 mA)		150	mA

USB-Revision

Table 2-7 indicates the revision and description of the USB-Blaster.

Revision	Descriptions	RoHS Compliant
Rev. A (1)	10-pin female connector is connected to the USB-Blaster through a ribbon cable.	No
Rev. B	10-pin female connector is connected to the USB-Blaster through a flexible PCB cable.	No
Rev. C	Hardware upgrade to meet the RoHS lead-free requirement. 10-pin female connector is connected to the USB-Blaster through a flexible PCB cable.	Yes

Note to Table 2-7:

- (1) Revision B and Revision C cable has a "Rev. B" and "Rev. C" marking on the casing. However, you can identify the Revision A cable if the cable is using a ribbon cable and does not have the revision marking.

References

For more information on configuration and in-system programmability (ISP), see the following sources:

- *AN 39: IEEE 1149.1 (JTAG) Boundary-Scan Testing in Altera Devices*
- *AN 95: In-System Programmability in MAX Devices*
- *AN 250: Configuring Cyclone FPGAs*
- *Configuring Stratix II Devices* chapter in Volume 2 of the *Stratix II Device Handbook*
- *Configuring Stratix and Stratix GX Devices* chapter in the *Stratix Device Handbook*
- *Configuring Cyclone II Devices* chapter in the *Cyclone II Handbook*
- *Serial Configuration Devices Data Sheet*
- *Programming & Configuration* chapter in the *Introduction to Quartus II* manual
- The Programming module of the Quartus II online tutorial
- Refer to the following glossary definitions in the Quartus II Help:
 - “USB-Blaster Cable” (general description)
 - “Configuration scheme” (general description)
 - “Programming files” (general description)
- Refer to the following procedures in the Quartus II Help:
 - Programming a Single Device or Multiple Devices in JTAG or Passive Serial Mode
 - Programming a Single Device in Active Serial Programming Mode
- Refer to the following introduction and overview topics in the Quartus II Help:
 - Programmer Introduction
 - Overview: Working with Chain Description Files
 - Overview: Converting Programming Files

